



# PRODUCT SPECIFICATION

**Model No : CSST-NLAWWGA95-M4X**

Descriptions:	
• LED Type	: White SMD LED : PLCC2 3.5x2.8 x0.8mm
• Emitting Color	: Warm White
• Encapsulation	: Silicone Resin



CUSTOMER APPROVED SIGNATURES	APPROVED BY	CHECKED BY	PREPARED BY
			

**OPTO PLUS TECHNOLOGIES CO.,LTD**

Address : No.696, Yangming North Rd, ShaoXing

City, ZheJiang Province, P.R.China , 312000

Tel : 86-575-88623888

Fax : 86-575-88623112

<http://www.csbright.com>

### ■ Features –

1. High luminous intensity using InGaN dice Technology
2. High reliability package due to silicone encapsulation
3. Wide viewing angle at 120 °
4. RoHS Compliant
5. Compatible Lead-Free Reflow Soldering process
6. JEDEC MSL 2a

### ■ Applications –

1. General lighting
2. Architecture and entertainment lighting
3. Electronic signs and signals
4. Interior automotive lighting

### ■ Absolute Maximum Rating Polarity–

(Ta=25°C)

Parameter	Symbol	Rating	Unit
Power Dissipation	Pd	280	mW
Forward Current	I <sub>F</sub>	90	mA
Peak Forward Current*	I <sub>FP</sub>	120	mA
Reverse Voltage*	V <sub>R</sub>	5	V
LED Junction Temperature*	T <sub>j</sub>	110	°C
Operating Temp.	T <sub>opr</sub>	-40~ +85	°C
Storage Temp.	T <sub>stg</sub>	-40 ~ +100	°C
Soldering Temp.	T <sub>sol</sub>	Reflow Soldering : 260°C for 10 sec Hand Soldering : 350°C for 3 sec	

#### Notes:

1. Pulse width  $\leq$  0.1 msec, duty  $\leq$  1/10
2. Proper current rating must be observed to maintain junction temperature below the maximum at all the time.
3. The device can not operated under continuous reverse voltage

■ Package Outline Dimensions –

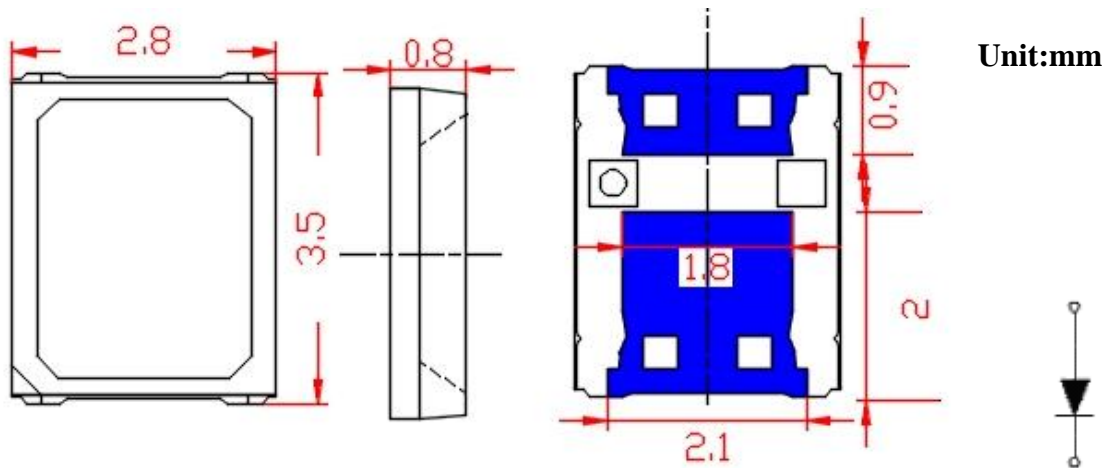

Notice: Tolerance of measurement of Dimension:  $\pm 0.2\text{mm}$

■ Recommended Soldering Pad Pattern

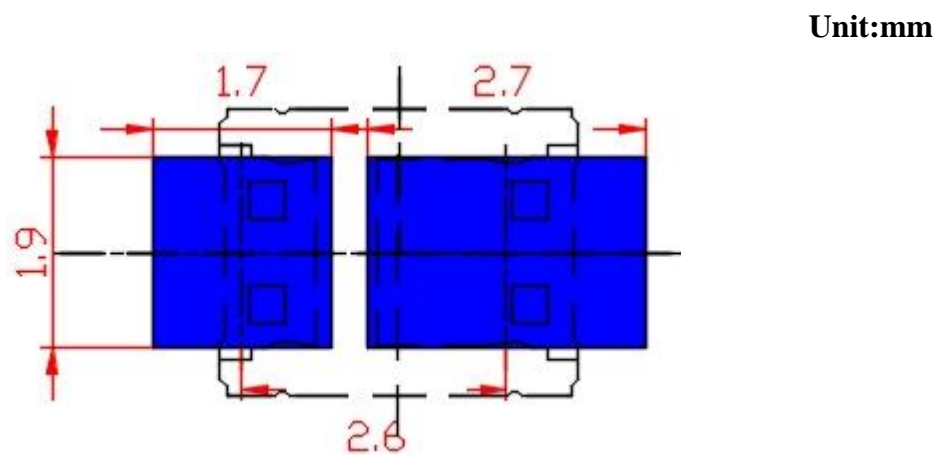

■ Electrical / Optical Characteristics –

( $T_a=25^\circ\text{C}$ )

Parameter	Symbol	Min.	Typ.	Max.	Unit	Condition
Forward Voltage	$V_F$		3.1		V	$I_F=60\text{mA}$
Luminous Flux	$\Phi_V$		19		lm	
Viewing Angle	$2\theta_{1/2}$		120		deg	
Color Rendering Index	$R_a$	90	95			
Reverse Current	$I_R$			10	$\mu\text{A}$	$V_R=5\text{V}$

■ Luminous Flux Rank Limits (  $I_F = 60\text{mA}$  )

unit : lm

Luminous Flux Part No.	P157	P173	P190	P230	P253
CSST- NLAWWGA95-M4X	15.7-19.3	17.3-19.0	19.0-23.0	23.0-25.3	25.3-28

Notice: Tolerance of measurement of Luminous Flux :  $\pm 7\%$

■ Forward Voltage Rank Limits –

$V_F$ Rank	Min	Max	Unit	Condition
V28	2.8	2.9	V	$I_F = 60\text{mA}$
V29	2.9	3.0		
V30	3.0	3.1		
V31	3.1	3.2		
V32	3.2	3.3		
V33	3.3	3.4		

Notice: Tolerance of measurement of Forward Voltage:  $\pm 0.1\text{V}$

■ Color Rank Limits (  $I_F = 60\text{mA}$  )

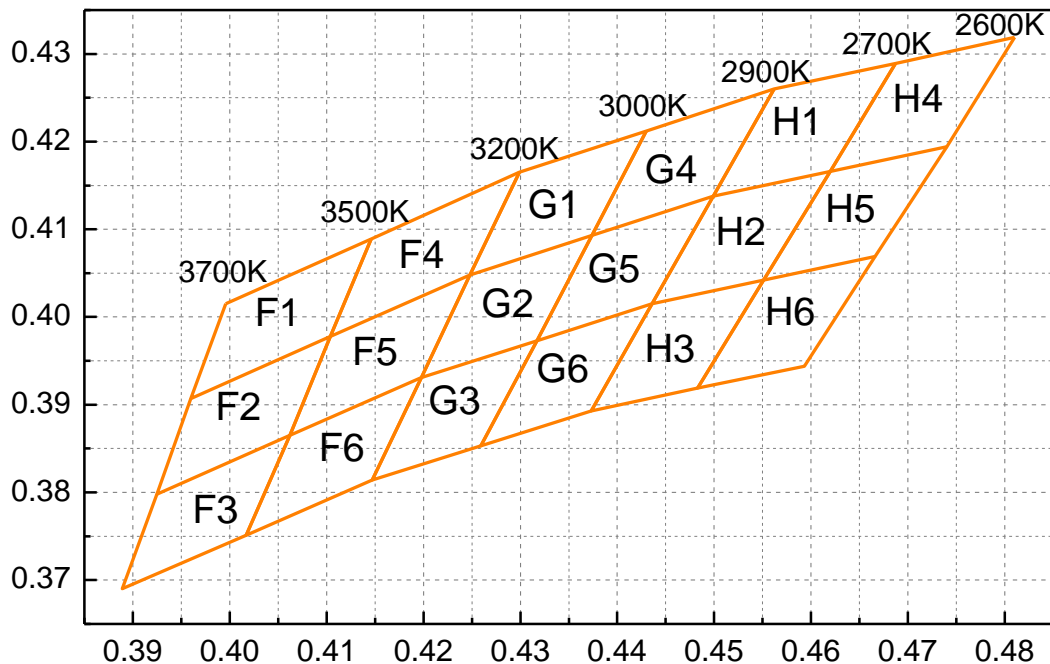

Rank F Color Temperature:3500~3700K					
F1		F2		F3	
CIE X	CIE Y	CIE X	CIE Y	CIE X	CIE Y
0.3996	0.4015	0.396	0.3907	0.3925	0.3798
0.3960	0.3907	0.3925	0.3798	0.3889	0.369
0.4104	0.3978	0.4062	0.3865	0.4017	0.3751
0.4146	0.4089	0.4104	0.3978	0.4062	0.3865

Rank F Color Temperature:3200~3500K					
F4		F5		F6	
CIE X	CIE Y	CIE X	CIE Y	CIE X	CIE Y
0.4146	0.4089	0.4104	0.3978	0.4062	0.3865
0.4104	0.3978	0.4062	0.3865	0.4017	0.3751
0.4248	0.4048	0.4198	0.3931	0.4147	0.3814
0.4299	0.4165	0.4248	0.4048	0.4198	0.3931

Rank G Color Temperature:3000~3200K					
G1		G2		G3	
CIE X	CIE Y	CIE X	CIE Y	CIE X	CIE Y
0.4299	0.4165	0.4248	0.4048	0.4198	0.3931
0.4248	0.4048	0.4198	0.3931	0.4147	0.3814
0.4374	0.4093	0.4317	0.3973	0.4259	0.3853
0.4430	0.4212	0.4374	0.4093	0.4317	0.3973

Rank G Color Temperature:2900~3000K					
G4		G5		G6	
CIE X	CIE Y	CIE X	CIE Y	CIE X	CIE Y
0.4430	0.4212	0.4374	0.4093	0.4317	0.3973
0.4374	0.4093	0.4317	0.3973	0.4259	0.3853
0.4499	0.4138	0.4436	0.4015	0.4373	0.3893
0.4562	0.426	0.4499	0.4138	0.4436	0.4015

Rank H Color Temperature:2700~2900K					
H1		H2		H3	
CIE X	CIE Y	CIE X	CIE Y	CIE X	CIE Y
0.4562	0.426	0.4499	0.4138	0.4436	0.4015
0.4499	0.4138	0.4436	0.4015	0.4373	0.3893
0.4620	0.4166	0.4551	0.4042	0.4483	0.3919
0.4687	0.4289	0.462	0.4166	0.4551	0.4042

Rank H Color Temperature:2600~2700K					
H4		H5		H6	
CIE X	CIE Y	CIE X	CIE Y	CIE X	CIE Y
0.4687	0.4289	0.462	0.4166	0.4551	0.4042
0.4620	0.4166	0.4551	0.4042	0.4483	0.3919
0.4740	0.4194	0.4666	0.4069	0.4593	0.3944
0.4810	0.4319	0.474	0.4194	0.4666	0.4069

**Notice : Tolerance of measurement of Color Coordinates :  $\pm 0.01$**

**■ Typical Electrical / Optical Characteristics Curves –**

**(Ta = 25°C Unless Otherwise Noted)**

**Figure1 Forward Current VS Ambient Temperature**

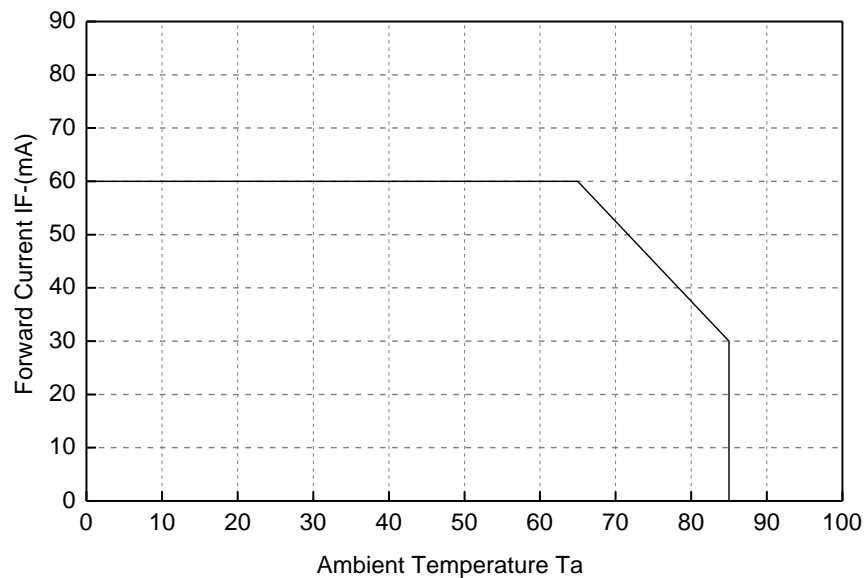

**Figure2. Forward Current VS. Forward Voltage**

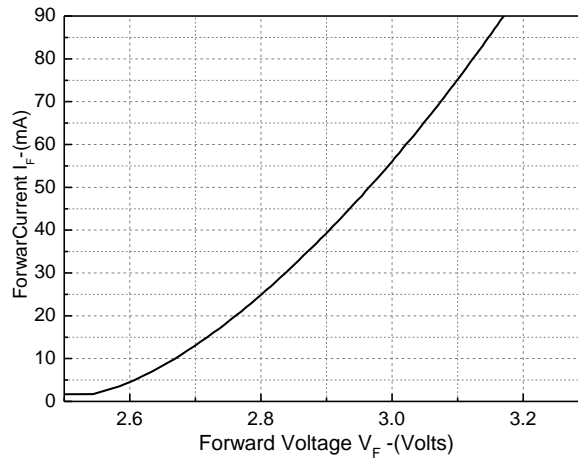

**Figure3. Relative Luminous Flux VS. Forward Current**

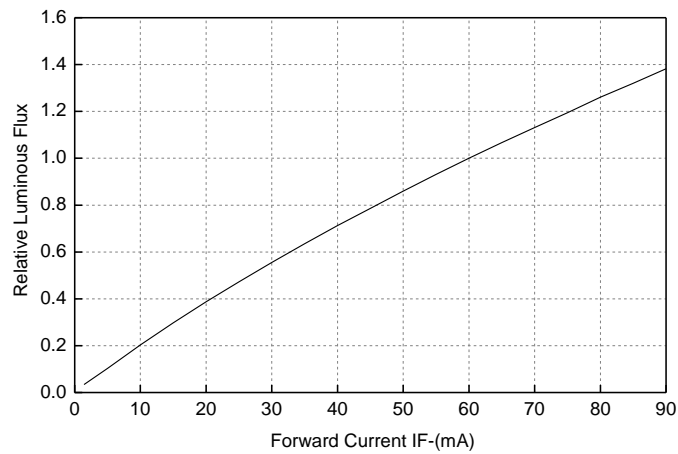

**Figure4. CIE X VS. Forward Current**

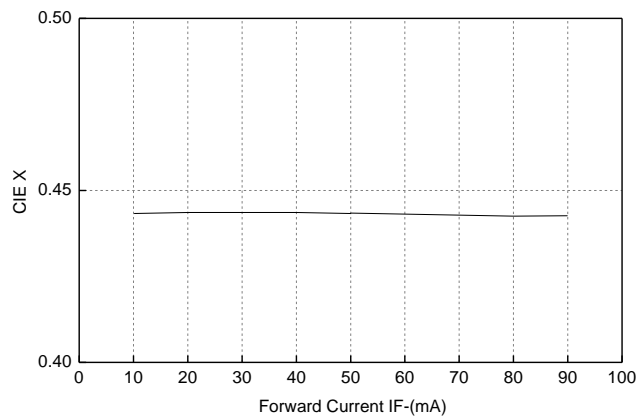

**Figure5. CIE Y VS. Forward Current**

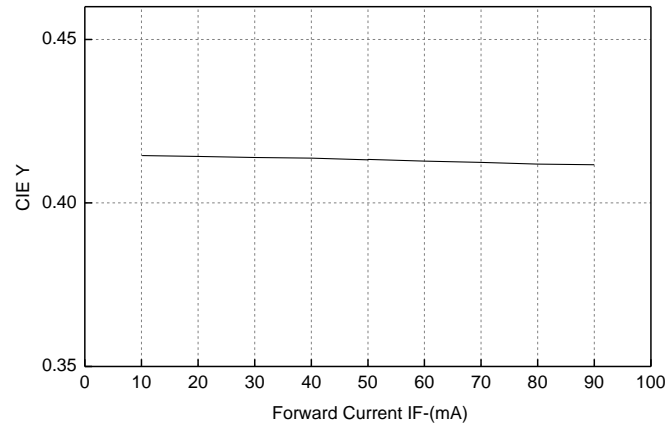

**Figure6. Relative Luminosity VS. Radiation Angle**

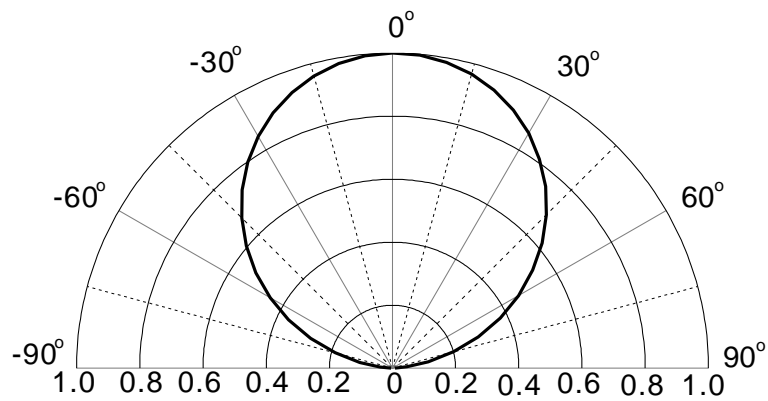

**Figure7. Relative Spectral Power Distribution VS. Wavelength**

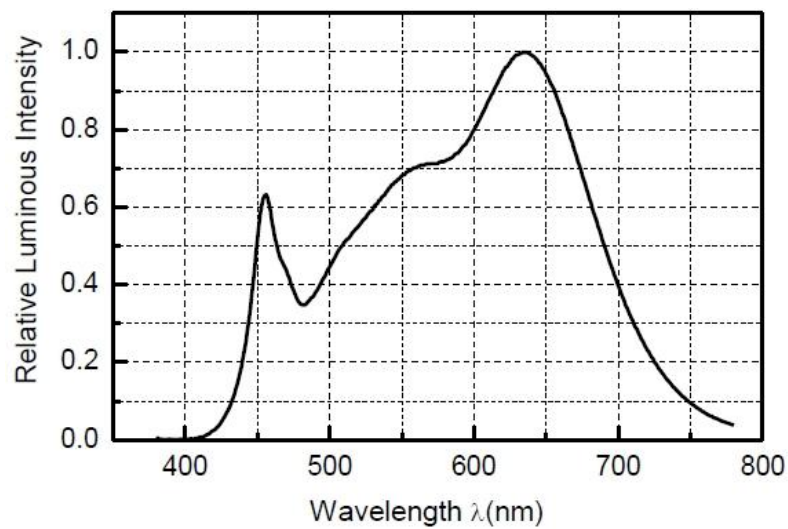



■ Package –

1. Tape Dimension

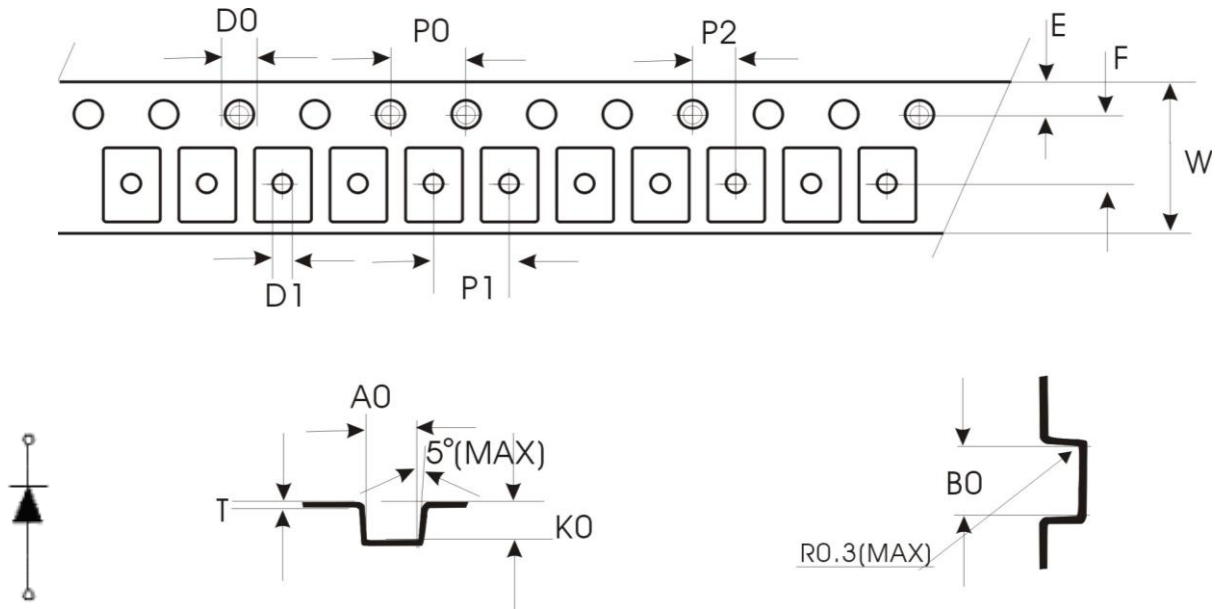

Unit: mm

Symbol	A0	B0	K0	P0	P1	P2	T
Spec	3.0±0.1	3.8±0.1	1.0±0.1	4.0±0.1	4.0±0.1	2.00±0.1	0.22±0.05
Symbol	E	F	D0	D1	W	P0	
Spec	1.75±0.10	3.50±0.05	1.5±0.1	1.0±0.1	8.0±0.1	40.0±0.2	

**2. Reel Dimension**

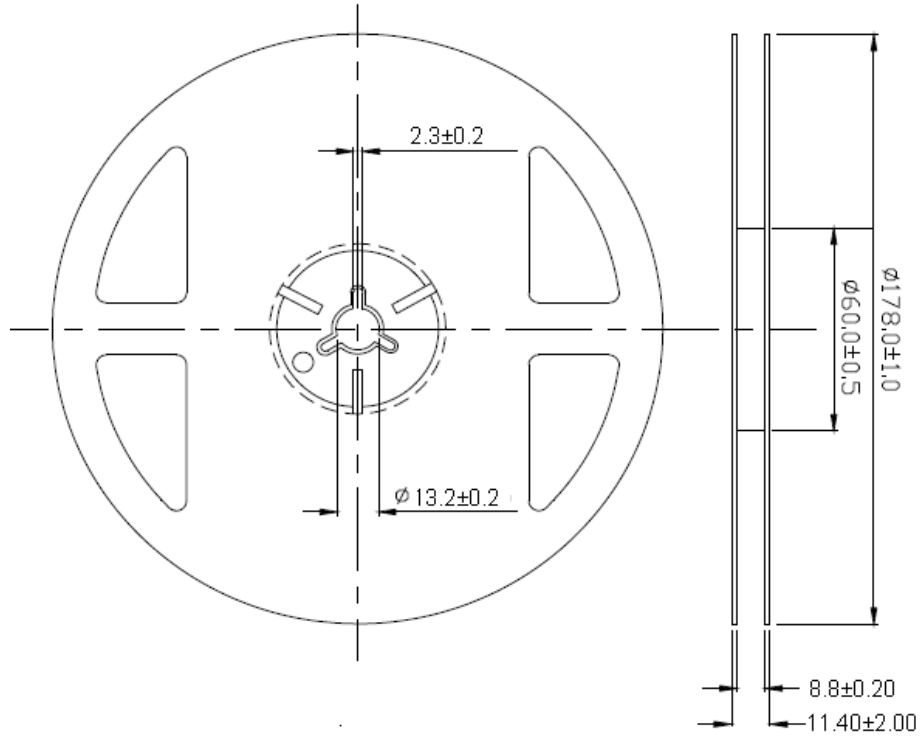

Unit: mm

**Notice: (1) Quantity:4000PCS/Reel**  
**(2)Tolerance unless mentioned is  $\pm 0.2$ mm**

**3. Packing Model**

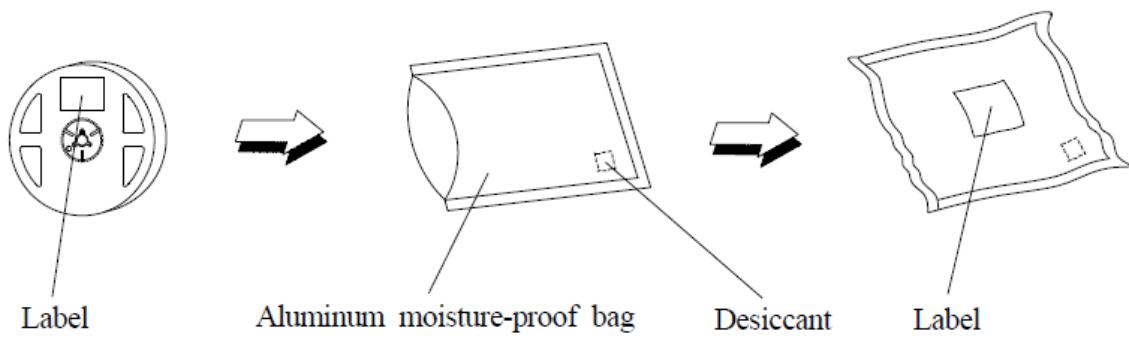

■ Packing Amount

Package Name	Package Dimension		Distribution of the layer or box		Total Mount		Note
	Size	Unit	Amount	Unit	Amount	Unit	
Reel	Φ178X11.4	mm	1	Reel	4000	Pcs	
Inner Box	265X235X78	mm	5	Reel	20000	Pcs	
Outer Box	540x260x170	mm	4	Inner Box	80000	Pcs	

■ Soldering Characteristics

IR-reflow Condition (Pb free)

Area	Title	Symbol	Min	Max	Unit
(1)Preheat	Ramp-up rate	Vp	1	5	°C/sec
	temperature	Tp	150	–	°C
	time	tp	–	–	sec
(2)Equilibrium	Ramp-up rate	Ve	–	–	°C/sec
	temperature	Te	150	200	°C
	Time	te	60	120	sec
(3)Reflow	Ramp-up rate	Vr	1	5	°C/sec
	temperature	Tr	220	–	°C
	Time	tr	–	60	sec
	Peak temperature	Trp	–	260	°C
	Peak time	trp	–	10	sec
(4)Cooling	Ramp-down rate	Vc	3	6	°C/sec

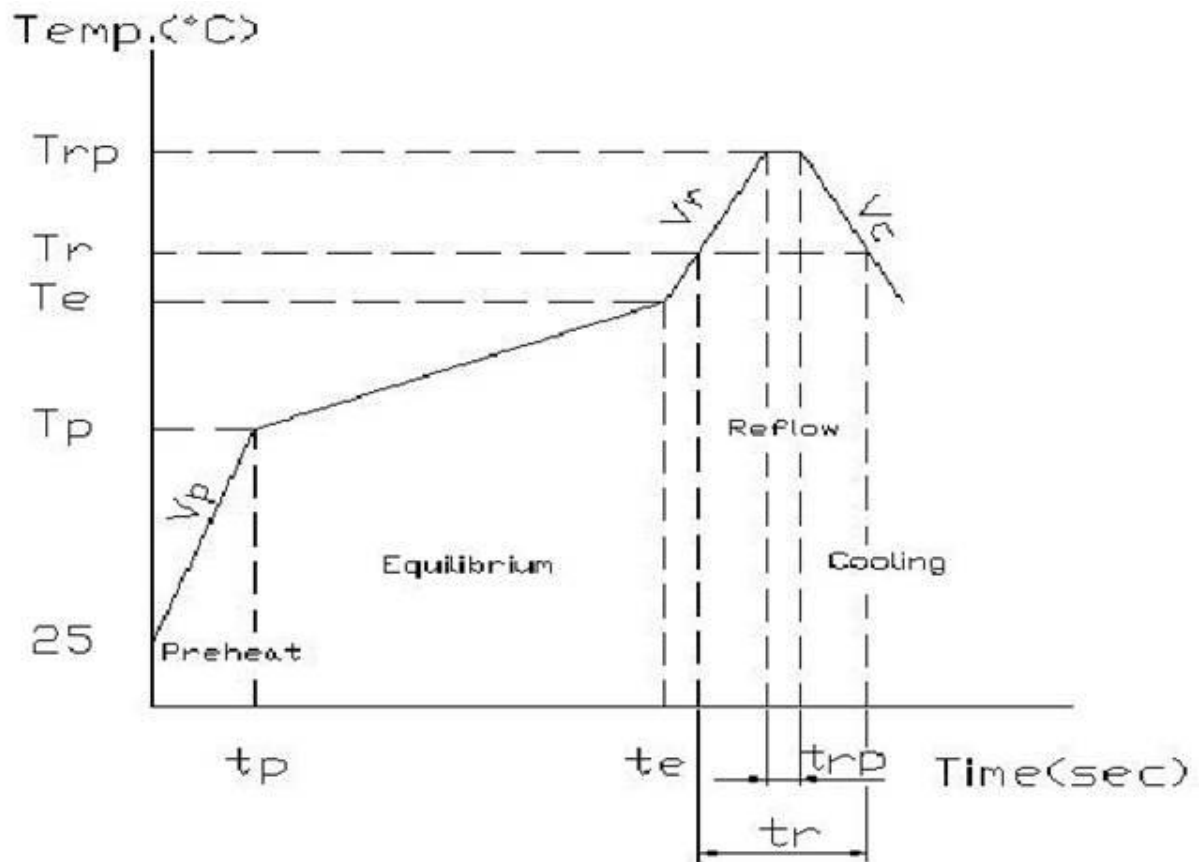

**Hand Soldering (Iron Condition)**

Soldering Iron:30W Max

Temperature 350°C Max (iron tip 260° C Max)

Soldering Time:3 Seconds Max(Once)

■ Reliability Test Program/ Reliability Test Item

NO.	Test Item	Standard	Test Conditions	Test	Failure	Units
		Test Method		Duration	Criteria	Failed/Tested
1	Resistance to Soldering Heat	JEITA ED-4701 300 301	Tsld=260°C, 10sec,reflows Pretreatment30°C,70%,168hrs		#1	0/20
2	Solderability (Reflow Soldering)	JEITA ED-4701 300 303A	Tsld=245±5°C,5sec. Lead-free Solder(Sn-3.0Ag-0.5Cu)		#3	0/20
3	Thermal Shock	JEITA ED-4701 300 307	-40°C~110°C 10min dwell, 10sec transfer,	100cycle s	#1	0/20
4	Temperature Cycle	JEITA ED-4701 100 105	-40°C (30min) ~25°C (5min) ~ 110°C (30min) ~25°C (5min)	100cycle s	#1	0/20
5	High Temperature Storage	JEITA ED-4701 200 201	Ta=110°C	1000hrs.	#1	0/20
6	Temperature Humidity	JEITA ED-4701 100 103	Ta=60°C, RH=90%	1000hrs.	#1	0/20
7	Low Temperature Storage	JEITA ED-4701 200 202	Ta=-40°C	1000hrs.	#1	0/20
8	Room Temperature Operating life		Ta=25°C, IF=60mA	1000 hrs.	#2	0/20
9	Low Temperature Operating life		Ta=-40°C, IF=60mA	1000hrs.	#2	0/20

### Failure Criteria

Criteria #	Items	Conditions	Failure Criteria
#1	Forward Voltage(VF)	IF=60mA	>U.S.L.X1.1
	Luminous Intensity(IV)	IF=60mA	<L.S.L.X0.7
#2	Forward Voltage(VF)	IF=60mA	>U.S.L.X1.1
	Luminous Intensity(IV)	IF=60mA	<L.S.L.X0.5
#3	Solderability		Less than 95% solder coverage

U.S.L.: Upper Specification limit    L.S.L.: Lower Specification Limit

## ■ Handling of Silicone Resin LEDs-

### ● Handling Indications

- i. When handling the product, do not touch it directly with bare hands as it may contaminate the surface and affect on optical characteristics. In the worst cases, excessive force to the product might result in catastrophic failure due to package damage and/or wire breakage.



- ii. When handling the product with tweezers, LEDs should only be handled from the side and make sure that excessive force is not applied to the resin portion of the product. Failure to comply can cause the resin portion of the product to be cut, chipped, delaminated and/or deformed, and wire to be broken, and thus resulting in catastrophic failure.



### ● Pick and place

Recommended conditions: Outer nozzle  $> \Phi 2.5\text{mm}$

Avoid direct contact to the encapsulant with picking up nozzle. Failure to comply might result in pick and place processes or damage to encapsulant. In the worst cases, catastrophic failure of the LEDs due to wire deformation and/or breakage.



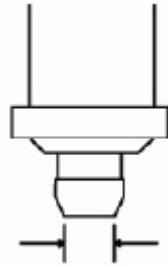

## ■ Storage –

- Storage Conditions
  - A. Before opening the package:  
The LEDs should be kept at  $\leq 40^{\circ}\text{C}$  and  $\leq 90\% \text{RH}$ . The LEDs should be used within a year. When storing the LEDs, moisture proof packaging with absorbent material (silica gel) is recommended.
  - B. After opening the package:  
The LEDs should be kept at  $\leq 30^{\circ}\text{C}$  and  $\leq 60\% \text{RH}$ . The LEDs should be soldered within 672 hours (4 weeks) after opening the package. If unused LEDs remain, they should be stored in moisture proof packages, such as sealed containers with packages of moisture absorbent material (silica gel). It is also recommended to return the LEDs to the original moisture proof bag and to reseal the moisture proof bag again.
- If the moisture absorbent material (silica gel) has faded away or the LEDs have exceeded the storage time, baking treatment should be performed using the following conditions.  
Baking treatment: more than 24 hours at  $60 \pm 5^{\circ}\text{C}$
- This product has silver plated metal parts that are inside and/or outside the package body. The silver plating becomes tarnished when being exposed to an environment which contains corrosive gases. Any LED with tarnished leads may lead to poor solderability and deterioration of optical characteristics. Please do not expose the LEDs to corrosive atmosphere during storage.
- After assembly and during use, silver plating can be affected by the corrosive gases emitted by components and materials in close proximity of the LEDs within an end product, and the gases entering into the product from the external atmosphere. The above should be taken into consideration when designing.

### ■ Moisture Proof Package –

- When moisture is absorbed into the SMT package it may vaporize and expand during soldering. There is a possibility that this can cause exfoliation of the contacts and damage to the optical characteristics of the LEDs. For this reason, the moisture proof package is used to keep moisture to a minimum in the package.
- The moisture proof package is made of an aluminum moisture proof bag. A package of a moisture absorbent material (silica gel) is inserted into the aluminum moisture proof bag. The silica gel changes its color from blue to red as it absorbs moisture.
- Please avoid rapid transitions in ambient temperature, especially in high humidity environments where condensation can occur.

### ■ Recommended circuit –

- In designing a circuit, the current through each LED must not exceed the absolute maximum rating specified for each LED. It is recommended to use Circuit B which regulates the current flowing through each LED. In the meanwhile, when driving LEDs with a constant voltage in Circuit A, the current through the LEDs may vary due to the variation in forward voltage (VF) of the LEDs. In the worst case, some LED may be subjected to stresses in excess of the absolute maximum rating.

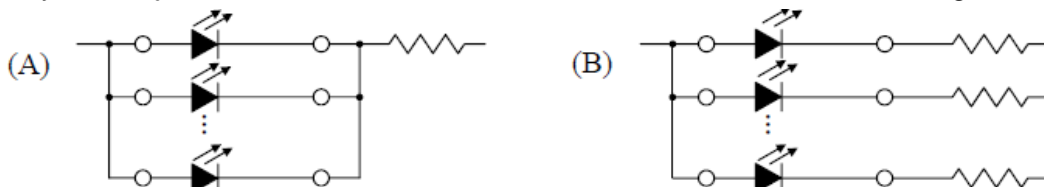

- This product should be operated in forward bias. A driving circuit must be designed so that the product is not subjected to either forward or reverse voltage while it is off. In particular, if a reverse voltage is continuously applied to the product, such operation can cause migration resulting in LED damage.

### ■ Heat Generation –

- Thermal design of the end product is of paramount importance. Please consider the heat generation of the LED when making the system design. The coefficient of temperature increase per input electric power is affected by the thermal resistance of the circuit board and density of LED placement on the board, as well as other components. It is necessary to avoid intense heat generation and operate within the maximum ratings given in this specification.
- The operating current should be decided after considering the ambient maximum

temperature of LEDs.

#### ■ **Static Electricity –**

- Static electricity or surge voltage damages the LEDs. It is recommended that a wrist band or an anti-electrostatic glove be used when handling the LEDs.
- All devices, equipment and machinery must be properly grounded. It is recommended that precautions be taken against surge voltage to the equipment that mounts the LEDs.
- When inspecting the final products in which LEDs were assembled, it is recommended to check whether the assembled LEDs are damaged by static electricity or not. It is easy to find static-damaged LEDs by a light-on test or a VF test at a lower current (below 1mA is recommended).
- Damaged LEDs will show some unusual characteristics such as the leak current remarkably increases, the forward voltage becomes lower, or the LEDs do not light at the low current.

Criteria: (VF > 2.0V at IF=0.5mA)

#### ■ **Cleaning –**

- It is recommended that isopropyl alcohol be used as a solvent for cleaning the LEDs. When using other solvents, it should be confirmed beforehand whether the solvents will dissolve the package and the resin or not. Freon solvents should not be used to clean the LEDs because of worldwide regulations.
- Do not clean the LEDs by the ultrasonic. When it is absolutely necessary, the influence of ultrasonic cleaning on the LEDs depends on factors such as ultrasonic power and the assembled condition. Before cleaning, a pre-test should be done to confirm whether any damage to the LEDs will occur.

■ Change story

REV.	Date	Change Description
A	2015.09.12	Original Version
B	2016.10.07	<ol style="list-style-type: none"> <li>1、 Change Package Outline Dimensions</li> <li>2、 Change Recommended Soldering Pad Pattern</li> </ol>
C	2018.11.15	<ol style="list-style-type: none"> <li>1. Change Electrical / Optical Characteristics</li> <li>2. Change Luminous Flux Rank Limits</li> </ol>
D	2023.03.16	<ol style="list-style-type: none"> <li>1. Change address</li> <li>2. Change Absolute Maximum Rating Polarity Notes</li> </ol>