



PRODUCT SPECIFICATION

Model No: CSLR-N508SB4-A0

Descriptions:	
■ Product Type	: Lighting LED Lamp
■ LED Package	: Round LED Lamp
■ Emitting Color	: Blue
■ Viewing Angle	: 45°
■ No Stopper	



CUSTOMER APPROVED SIGNATURES	APPROVED BY	CHECKED BY	PREPARED BY
			

OPTO PLUS TECHNOLOGIES CO.,LTD

Address : No.696, Yangming North Rd., ShaoXing

City,ZheJiang Province,P.R.China

Tel : 86-575-88623888

Fax : 86-575-88623112

<http://www.csbright.com>

Spec. No.	PS-LR-N508SB4-A0
Rev.	F

Model No.: CSLR-N508SB4-A0

■ **Feature**

1. Low Power Consumption.
2. High Luminous Output.
3. High Reliability and Solid.
4. Optimal Optical/Mechanical Design.
5. RoHS compliant.

■ **Device Selection Guide**

Part No.	Chip	Color	
	Material	Emitted	Lens Resin
CSLR-N508SB4-A0	InGaN	Blue	Water Transparent

■ **Applications**

1. Amusement
2. Architecture and entertainment lighting
3. Electronic signs and signals.

Model No.: CSLR-N508SB4-A0

■ **Absolute Maximum Ratings**

Parameter	Symbol	Rating	Unit
Power Dissipation	Pd	96	mW
Continuous Forward Current	I _f	30	mA
Peak Forward Current (Duty Cycle 1/10,1KHz) ^{*1}	I _{fP}	100	mA
Reverse Voltage ^{*2}	V _r	5	V
ESD Sensitivity	ESD	1000	V
LED Junction Temperature ^{*3}	T _j	110	°C
Operating Temperature	Topr	-40~ +85°C	
Storage Temperature	Tstg	-40 ~ +100°C	
Lead Soldering Temperature	Tsol	Max. 260 for 5 sec Max. (1.6mm from the epoxy body)	

Note:

1. Pulse width \cong 0.1 msec, duty \cong 1/10.
2. The device can not operated under continuous reverse voltage.
3. Proper current rating must be observed to maintain junction temperature below the maximum at all the time.

Model No.: CSLR-N508SB4-A0

■ **Electrical / Optical Characteristic**

Parameter	Symbol	Min	Typ	Max	Unit	Condition
Luminous Intensity*	I_v	1800	3300	-----	mcd	If = 20mA
Forward Voltage	V_f	-----	3.3	3.6	V	
Dominant Wavelength	λ_d	-----	465	-----	nm	
Viewing Angle	$2\theta_{1/2}$	-----	45	-----	Deg	
Reverse Current	I_r	-----	-----	10	μ A	Vr = 5V
ESD Sensitivity	HBM	-----	-----	1000	V	MIL-STD-833G

* Luminous intensity value is traceable to CIE127-2007 standards

■ **Package Outline Dimensions**

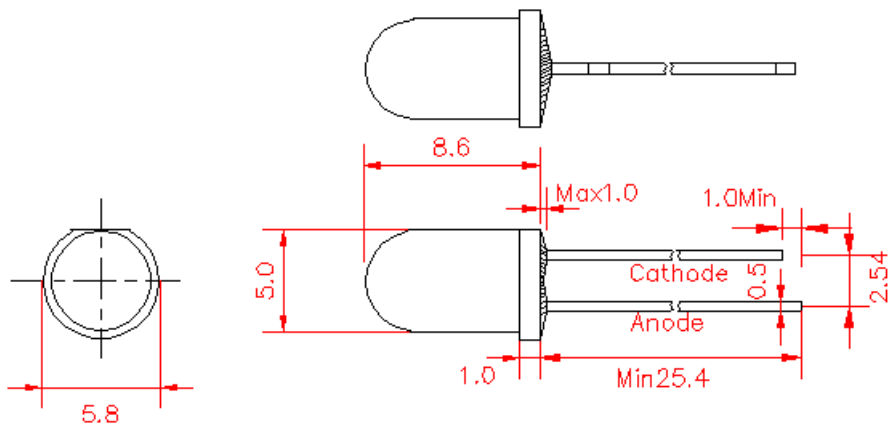

※ Tolerance: ± 0.25 Unit: mm

Model No.: CSLR-N508SB4-A0

■ **Luminous Intensity Rank Limits (If = 20mA)**

Luminous Intensity			
Bin Code	Min	Max	Unit
31	1800	2300	mcd
32	2300	3000	
33	3000	3900	
34	3900	5100	

■ **Dominant Wavelength Rank Limits(If = 20mA)**

Bin Code	Min	Max	Unit
B5	460	465	nm
B6	465	470	
B7	470	475	

■ **Forward Voltage Rank Limits(If = 20mA)**

Bin Code	Min	Max	Unit
H	2.8	3.0	V
J	3.0	3.2	
K	3.2	3.4	
L	3.4	3.6	

Notes:

1. Tolerance of measurement of luminous intensity :±15%;
2. Tolerance of measurement of dominant wavelength:±2nm;
3. Tolerance of measurement of forward voltage:±0.1v;
4. All data are measured by OPT's test equipment.
5. One delivery will include several color rank, VF rank and Iv ranks of the products.
6. The quantity-ratio of the ranks is decided by OPT.

Model No.: CSLR-N508SB4-A0

■ **Electrical / Optical Characteristics Curves (Ta = 25°C Unless Otherwise Noted)**

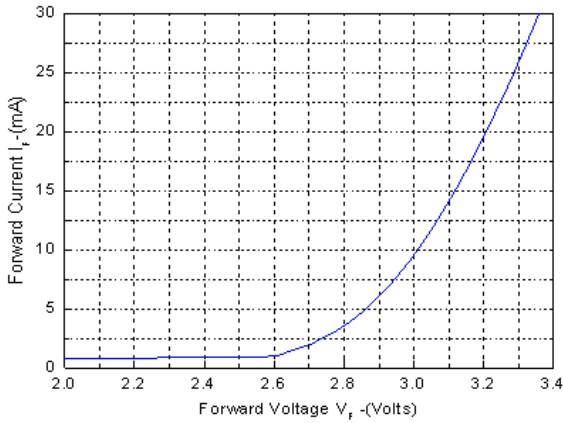

Figure1. Forward Current VS. Forward Voltage

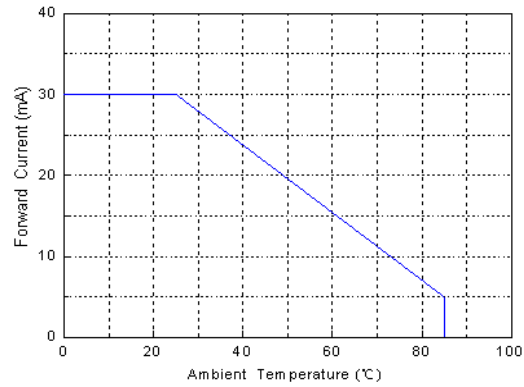

Figure2. Forward Current VS. Ambient Temperature;

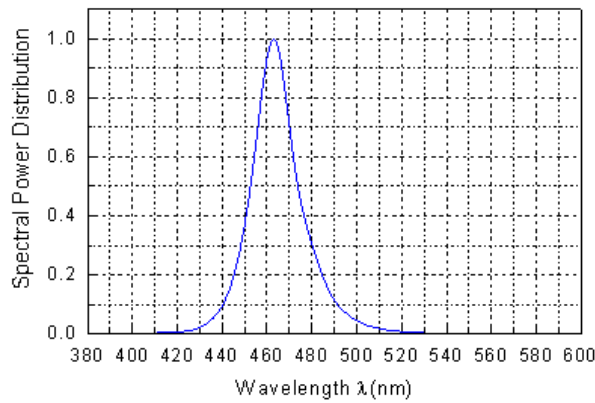

Figure3. Spectral Power Distribution VS. Wavelength

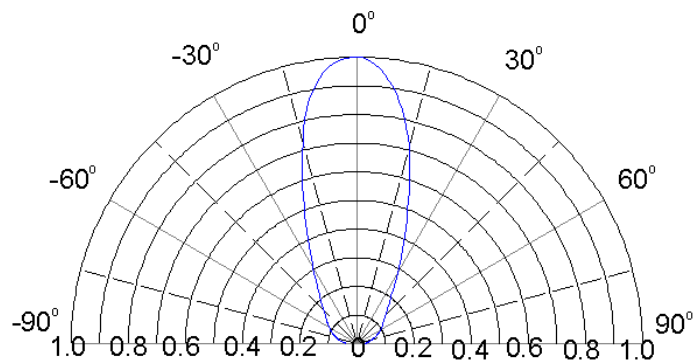

Figure4. Relative Luminosity VS. Radiation Angle

Model No.: CSLR-N508SB4-A0

■ Precautions For Use

1. Wave Soldering Profile

.Distance : 1.6 mm min (From seating plane)

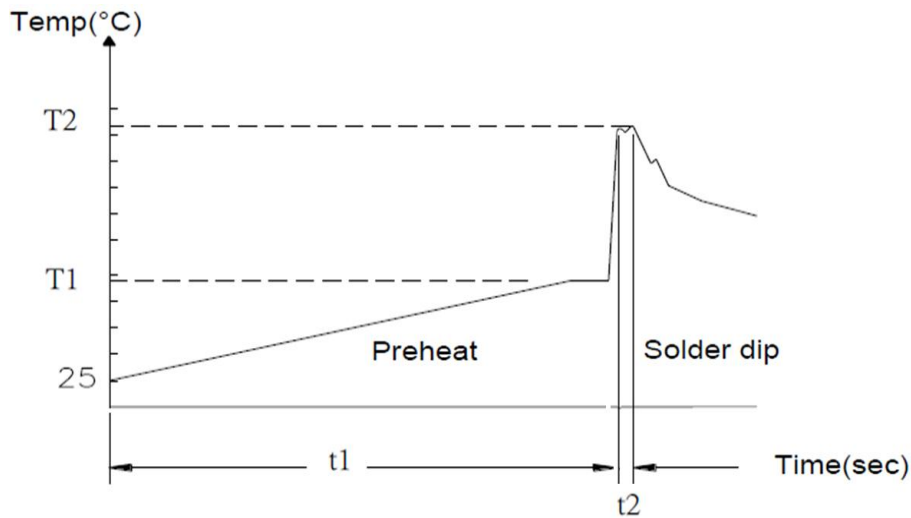

Item	Condition		Notes
Preheat	Temp. T1	120-180 °C	PWB temperature (soldering side surface)
	time t1	60-180 sec	
Solder Dip	Temp. T2	230-260 °C	Bath temperature
	time t2	2-4 sec	Solder tank passage time

2. Hand Soldering (Iron Condition)

- 2.1 Soldering Iron: 30W Max
- 2.2 Temperature 350°C Max (iron tip 260°C Max)
- 2.3 Soldering Time: 3 Seconds Max (Once)
- 2.4 Distance: 1.6mm min (From seating plane)

Model No.: CSLR-N508SB4-A0

3. Static Electricity

3.1 Static electricity or surge voltage damages LEDs.

It is recommended that a wrist band or an anti-electrostatic glove should be used when handling the LEDs.

3.2 All devices, equipment and machinery must be properly grounded. It is recommended that measures be taken against surge voltage to the equipment that mounts the LEDs.

4. Storage

4.1 Shelf life: Within 18 months under following conditions.

Un-opened, at normal temperature / Normal relative humidity (+5~+30°C / 70%Rh.max.).

■ Reliability Test Program/ Reliability Test Item Tests and Results

NO.	Test Item	Standard Test Method	Test Conditions	Test Duration	Failure Criteria	Units Failed/Tested
1	OPERATION LIFE	JESD22-A108	Ta= UNDER ROOM TEMPERATURE IF=20MA	1000HRS	#2	0/20
2	HIGH TEMPERATURE HIGH HUMIDITY BURN-IN	JEITA ED-4701/102A MIL-STD-750 1026 MIL-STD-830 1005	Ta=85°C RH= 85% IF=5MA	1000HRS	#2	0/20
3	LOW TEMPERATURE STORAGE	JEITA ED-4701/202A MIL-STD-750 1026 MIL-STD-830 1005	Ta= -55±5°C	1000HRS	#1	0/20
4	SOLDERABILITY	JEITA ED-4701/303A MIL-STD-202(210F)	LEAD FREE:T.sol= 245 ± 5°C(SnCu) DWELL TIME= 5± 1secs	/	#3	0/20

Notes:

Measurements are performed after allowing the LEDs to return to room temperature.

Model No.: CSLR-N508SB4-A0

Failure Criteria

Criteria #	Items	Conditions	Failure Criteria
#1	Forward Voltage(Vf)	IF=20mA	>U.S.L.X1.1
	Luminous Intensity(Iv)	IF=20mA	<L.S.L.X0.7
#2	Forward Voltage(Vf)	IF=20mA	>U.S.L.X1.1
	Luminous Intensity(Iv)	IF=20mA	<L.S.L.X0.5
#3	Solderability	/	Less than 95% solder coverage

U.S.L.: Upper Specification limit L.S.L.: Lower Specification Limit

Package

Package Name	Package Dimension		Distribution of the layer or box		Total Mount	
	Size	Unit	Amount	Unit	Amount	Unit
Bag	200*150	mm	1	Bag	500	PCS
Inner Box	303x220x150	mm	1	Box	8000	PCS
Outer Box	470x330x320	mm	1	Box	32000	PCS

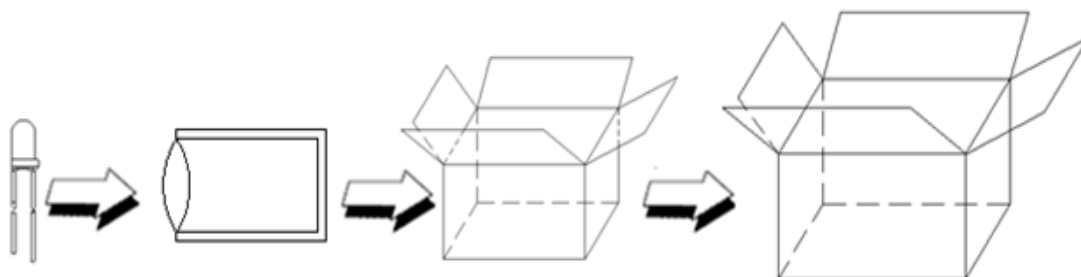

LED

Bag

Inner Box

Outer Box

Spec. No.	PS-LR-N508SB4-A0
Rev.	F

Model No.: CSLR-N508SB4-A0

■ Change story-

Rev.	Date	Change Description
A	2009/8/24	Original Version
B	2015/7/14	change the Luminous Intensity rank Limits
C	2017/11/8	Format to update Add different test standard rank limits
D	2019/6/9	Brightness level change
E	2019/9/10	1. Add remarks on rated specifications 2.Delete IV(2)
F	2023.03.15	1. Delete CS bright corporation's address; 2. Add side view to product;

Please confirm with OPT salesman, if your request different form standard specification.