

# PRODUCT SPECIFICATION

**Model No.: CSDS-S28124 CSDS-S28125**

Descriptions:
<ul style="list-style-type: none"> <li>■ 0.28 Inch Single Digit SMD Display</li> <li>■ CSDS-S28124 is Common Anode</li> <li>■ CSDS-S28125 is Common Cathode</li> <li>■ Emitting Color: Pure Green; Yellow Green; Yellow; Amber; Orange; Red; Deep Red</li> <li>■ Standard: -11: Gray face, white segment. -21: Black face, white segment.</li> </ul>



CUSTOMER APPROVED SIGNATURES	APPROVED BY	CHECKED BY	PREPARED BY

**OPTO PLUS TECHNOLOGIES CO.,LTD**  
 Address:No.696,Yangming North Rd,  
 ShaoXing City,ZheJiang Province, P.R.China.  
 Tel :86-575-88623888  
 Fax:86-575-88623112

**Model No.: CSDS-S28124 CSDS-S28125**

**■ Features -**

1. 0.28 inch (7.00mm) digit height
2. Qualified according to JEDEC moisture sensitivity Level 2a.
3. RoHS compliant.
4. Low power consumption.
5. Easy mounting on P.C. board .

**■ Device Selection Guide -**

Model No.	Chip	
	Material	Emitting Color
CSDS-S2812x2	AlGaInP	Pure Green
CSDS-S2812xM		Yellow Green
CSDS-S2812xT		Yellow
CSDS-S2812xA		Amber
CSDS-S2812xV		Orange
CSDS-S2812xL		Red
CSDS-S2812xU		Deep Red

**■ LED Numeric/Alphanumeric Display**

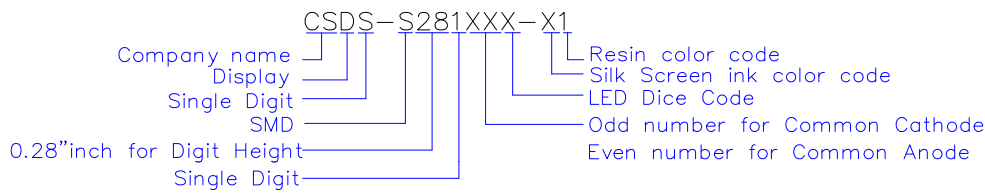

**■ Mechanical Dimensions -**

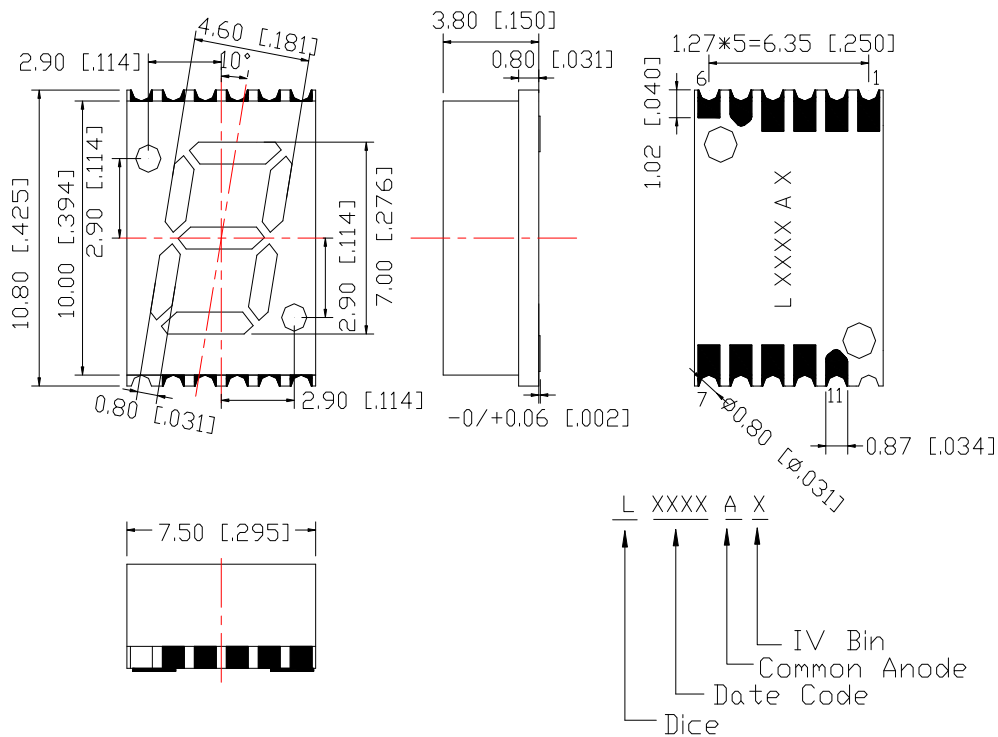

**Notes:**

1. Dimension in millimeter [inch], tolerance is  $\pm 0.25$  [0.010] and angle is  $\pm 1^\circ$  unless otherwise noted.
2. Bending  $\leq$  Length\*1%.

Model No.: CSDS-S28124 CSDS-S28125

■ All Light On Segments Feature & Pin Position

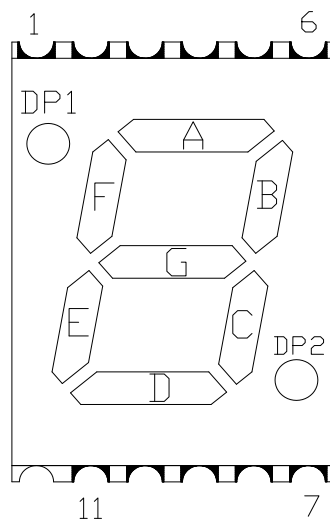

■ Internal Circuit Diagrams -

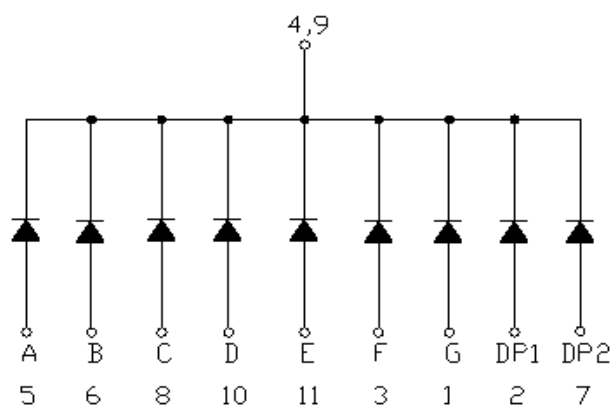
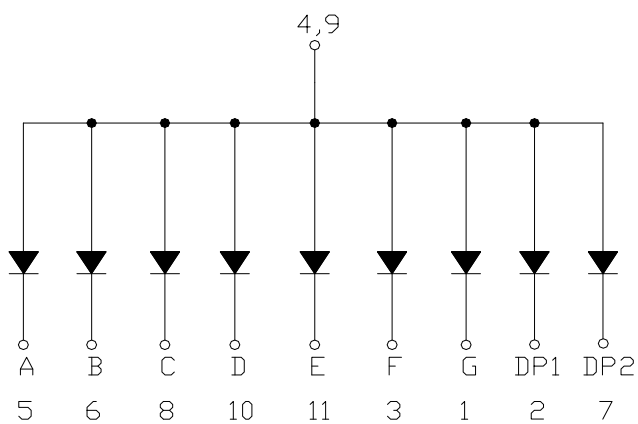

CSDS-S28124 is Common Anode

CSDS-S28125 is Common Cathode

Model No.: CSDS-S28124 CSDS-S28125

■ Absolute Maximum Rating -

(Ta=25°C)

Parameter	Symbol	Rating		Unit
		2	M/T/A/V/L/U	
Power Dissipation Per Dice	PAD	114	70	mW
Derating Liner from 25°C per Dice	-	0.4	0.33	mA/°C
Continuous Forward Current Per Dice	IAF	30	25	mA
Peak Current Per Dice(duty cycle 1/10,1KHz)	IPF	100	90	mA
Reverse Voltage Per Dice	VR	5	5	V
Electrostatic discharge(HBM)	ESD	1000	/	V
Operating Temp.	Topr	-40 ~ +105		°C
Storage Temp.	Tstg	-40 ~ +105		°C
Hand Soldering Temp.	Tsol	350		°C

■ Electro-optical Characteristics -

(Ta=25°C)

Parameter	Symbol	Chip	Min.	Typ.	Max.	Unit	Condition
Luminous Intensity Per Segment	Iv	2	-	40	-	mcd	If=10mA
		M	-	1.1	-		
		T	-	7	-		
		A	-	7.6	-		
		V	-	9	-		
		L	-	5.4	-		
		U	-	2.1	-		
Forward Voltage Per Segment	VF	2	-	3.2	3.8	V	If=20mA
		M/T/A/V/L/U	-	2	2.8		
Peak Emission Wavelength / Dominant Wavelength	λP/λd	2	-	*525	-	nm	If=20mA
		M	-	572/570	-		
		T	-	592/590	-		
		A	-	612/605	-		
		V	-	632/625	-		
		L	-	644/630	-		
		U	-	660/645	-		
Reverse Current	IR		-	-	100	μA	VR=5V
Luminous Intensity Matching Ratio	IV-m		-	-	2:1	-	If=10mA

**Model No.: CSDS-S28124 CSDS-S28125**

**Typical Electrical / Optical Characteristics Curves -**

(Ta = 25°C Unless Otherwise Noted)

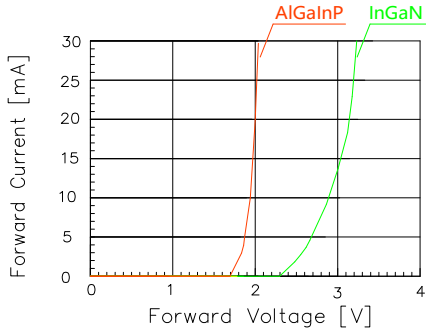

Fig 1. Forward Current vs. Forward Voltage

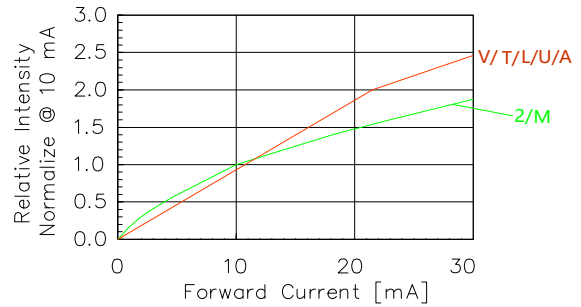

Fig 2. Relative Intensity vs. Forward Current

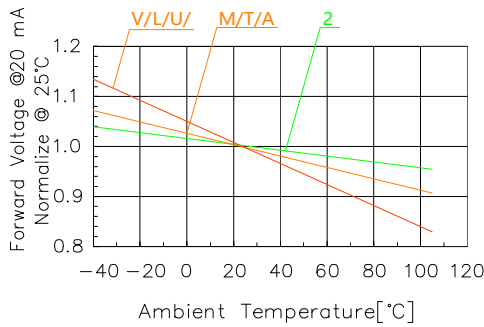

Fig 3. Forward Voltage vs. Temperature

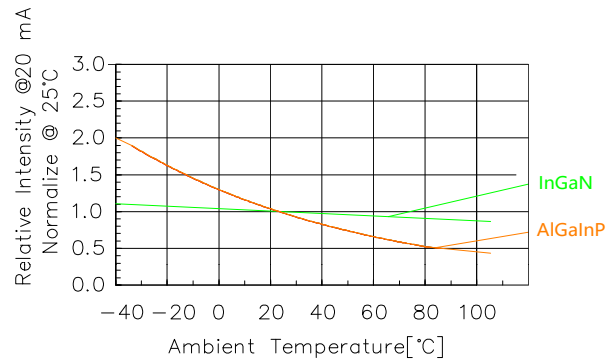

Fig 4. Relative Intensity vs. Temperature

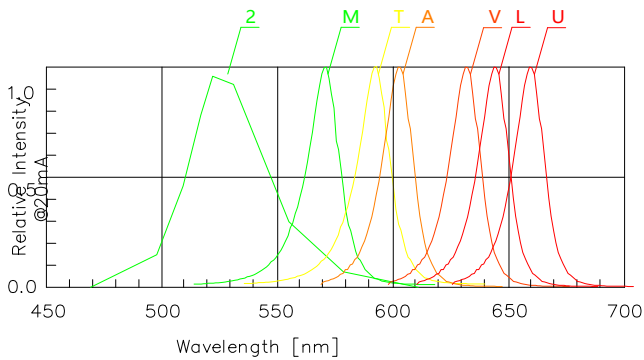

Fig 5. Relative Intensity vs. Wavelength

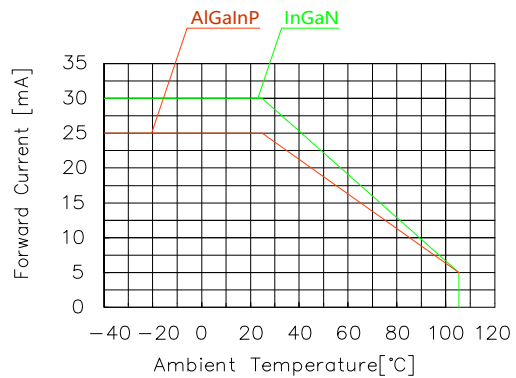
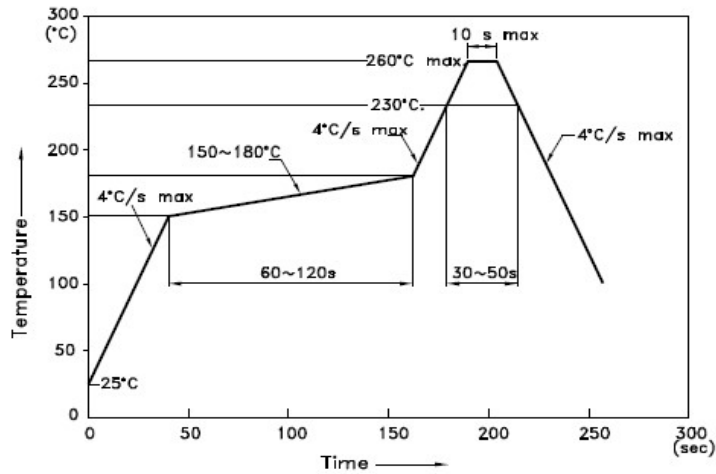

Fig 6. Forward current vs. Temperature

Model No.: CSDS-S28124 CSDS-S28125

## SMT REFLOW SOLDERING INSTRUCTIONS

### ■ IR Reflow Temperature / Time :



#### NOTES:

1. We recommend the reflow temperature 245°C(+/-5°C). The maximum soldering temperature should be limited to 260°C.
2. Don't cause stress to the epoxy resin while it is exposed to high temperature.
3. Number of reflow process shall be 2 times or less.

### ■ Soldering Pad Size

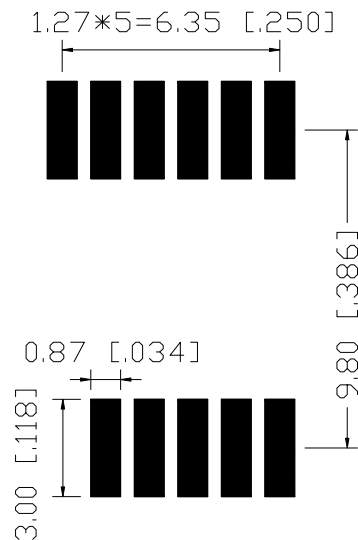

Model No.: CSDS-S28124 CSDS-S28125

REEL DIMENSIONS

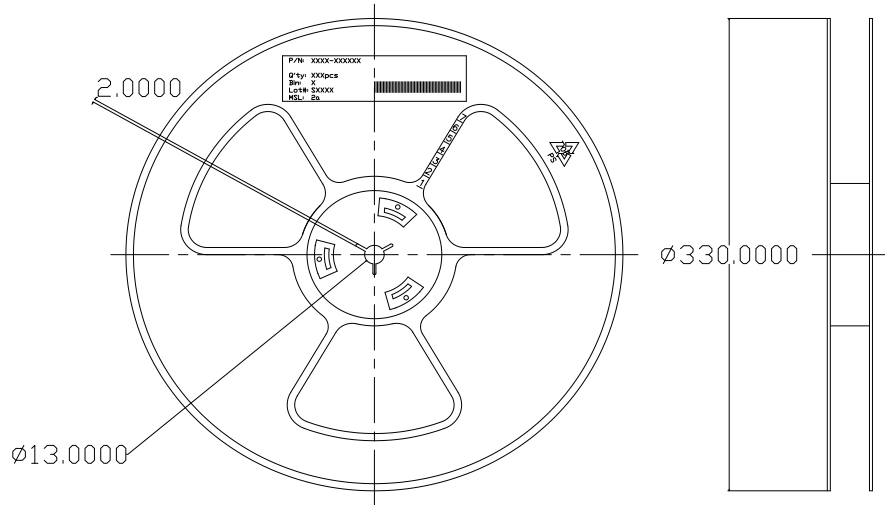

PACKING & LABEL SPECIFICATIONS

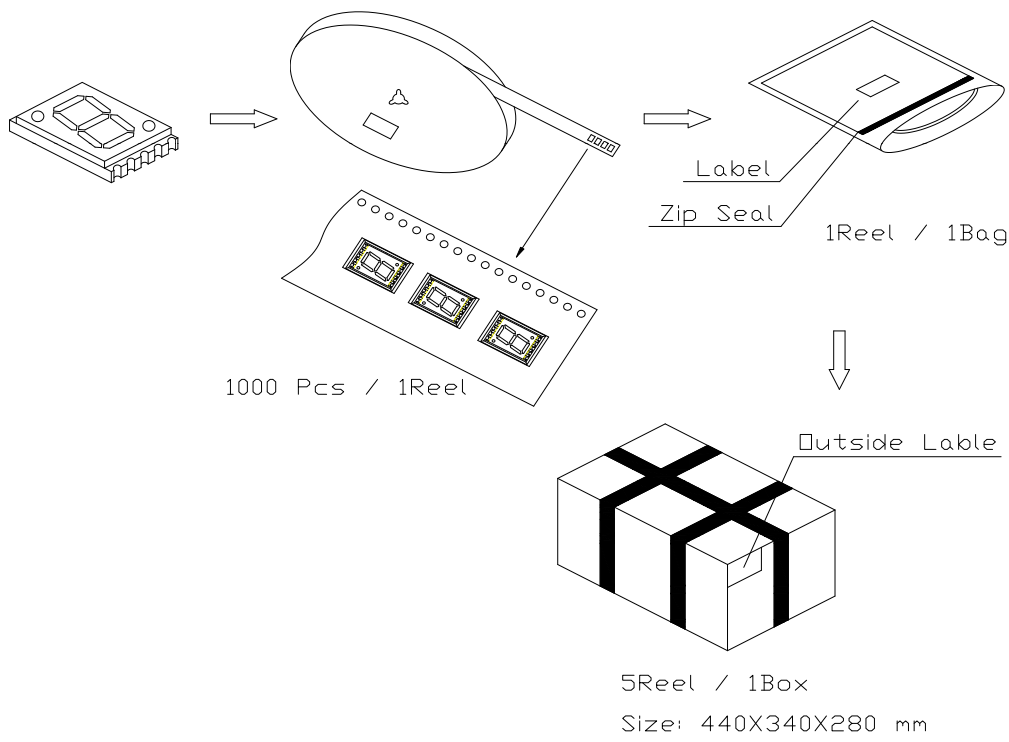

Note: The specifications are subject to change without notice. Please contact us for updated information.