

PRODUCT SPECIFICATION

Model No.: CSOM-88114B CSOM-88115B

Descriptions:
<ul style="list-style-type: none"> ■ 1.5 Inch Dot-Matrix Display ■ 8*8 Array with X-Y Select ■ CSOM-88114 is Common Column Cathode ■ CSOM-88115 is Common Column Anode ■ Emitting Color: Blue ■ Standard: -11: Gray face, white Dot. -21: Black face, white Dot.



CUSTOMER APPROVED SIGNATURES	APPROVED BY	CHECKED BY	PREPARED BY

OPTO PLUS TECHNOLOGIES CO.,LTD
 Address:No.696,Yangming North Rd,
 ShaoXing City,ZheJiang Province, P.R.China.
 Tel :86-575-88623888
 Fax:86-575-88623112

Model No.: CSOM-88114B CSOM-88115B

■ Features -

1. 1.5 inch (37.02mm) Matrix height.
2. Case mold type.
3. RoHS compliant.
4. Low power consumption.
5. Easy mounting on P.C. board or socket.

■ Device Selection Guide -

Model No.	Chip	
	Material	Emitting Color
CSOM-8811XB	InGaN	Blue

■ LED Numeric/Alphanumeric Display

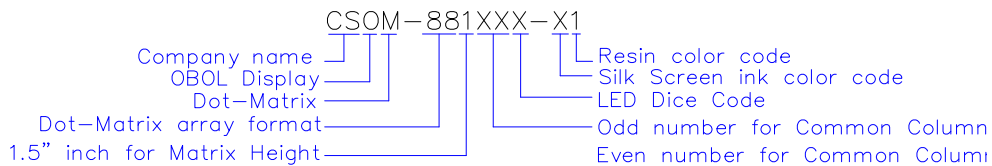

■ Mechanical Dimensions -

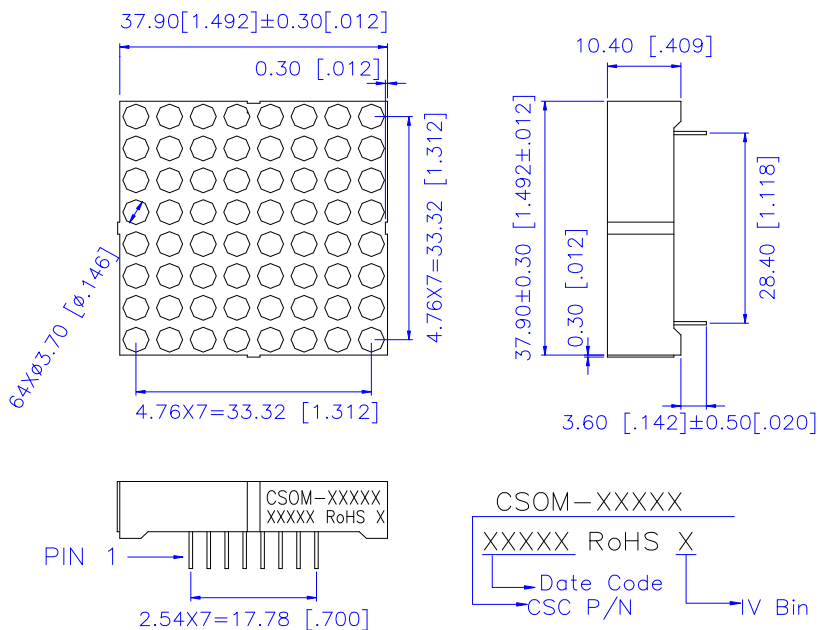

Notes:

1. All pins are $\Phi 0.51 [0.020] \pm 0.1 \text{ mm}$
2. Dimension in millimeter [inch], tolerance is $\pm 0.25 [0.010]$ and angle is $\pm 1^\circ$ unless otherwise noted.
3. Bending $\leq \text{Length} * 1\%$.

Model No.: CSOM-88114B CSOM-88115B

■ All Light On Segments Feature & Pin Position

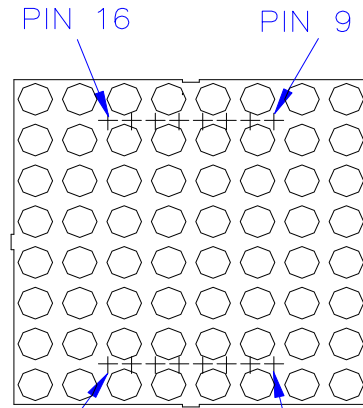

■ Internal Circuit Diagrams -

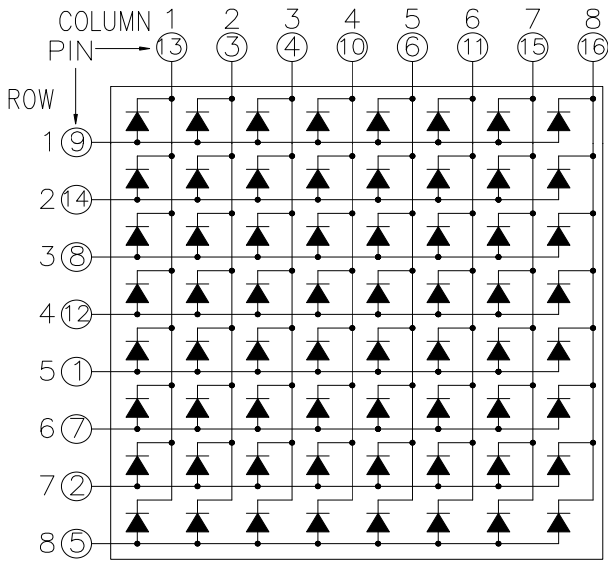

CSOM-88114 is Common Column Cathode

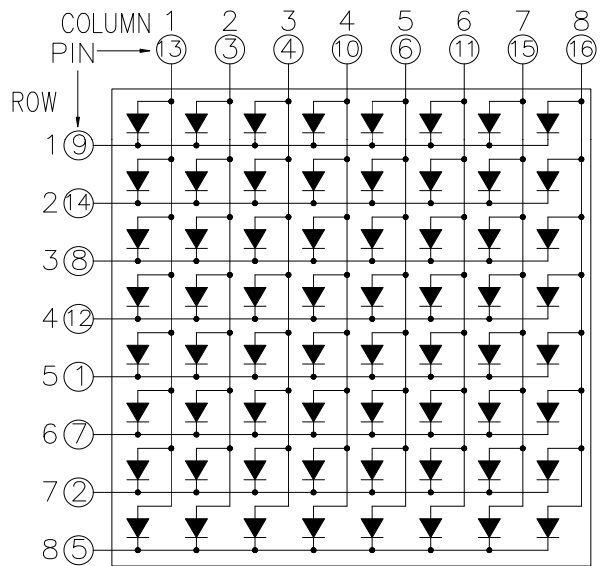

CSOM-88115 is Common Column Anode

Model No.: CSOM-88114B CSOM-88115B

■ Absolute Maximum Rating -

(Ta=25°C)

Parameter	Symbol	Rating	Unit
Power Dissipation Per Dice	PAD	114	mW
Derating Liner from 25°C per Dice	-	0.4	mA/°C
Continuous Forward Current Per Dice	IAF	30	mA
Peak Current Per Dice(duty cycle 1/10,1KHz)	IPF	100	mA
Reverse Voltage Per Dice	VR	5	V
Electrostatic discharge(HBM)	ESD	1000	V
Operating Temp.	Topr	-35 ~ +85	°C
Storage Temp.	Tstg	-35 ~ +85	°C
Hand Soldering Temp.	Tsol	350	°C

■ Electro-optical Characteristics -

(Ta=25°C)

Parameter	Symbol	Min.	Typ.	Max.	Unit	Condition
Forward Voltage Per Segment	V _F	-	3.2	3.8	V	I _F =20mA
Luminous Intensity Per Segment	I _v	-	72	-	mcd	I _F =10mA
Dominant Wavelength	λ _d	-	465	-	nm	I _F =20mA
Reverse Current	I _R	-	-	50	μA	VR=5V
Luminous Intensity Matching Ratio	I _{v-m}	-	-	2:1	-	*1

Notes: 1. *1 Condition is I_p=80mA 1/16Duty

2. The device can not operated under continuous reverse voltage.

■ Typical Electrical / Optical Characteristics Curves -

(Ta = 25°C Unless Otherwise Noted)

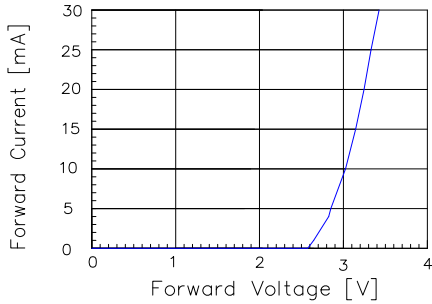

Fig 1. Forward Current vs. Forward Voltage

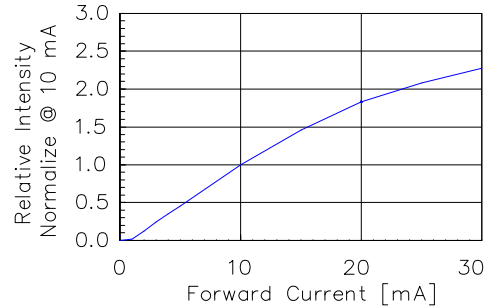

Fig 2. Relative Intensity vs. Forward Current

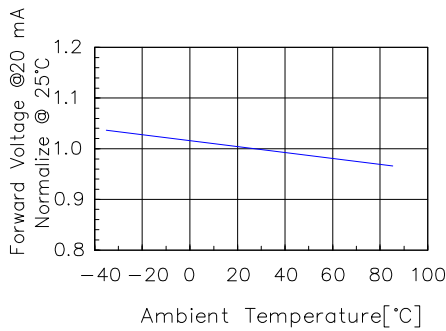

Fig 3. Forward Voltage vs. Temperature

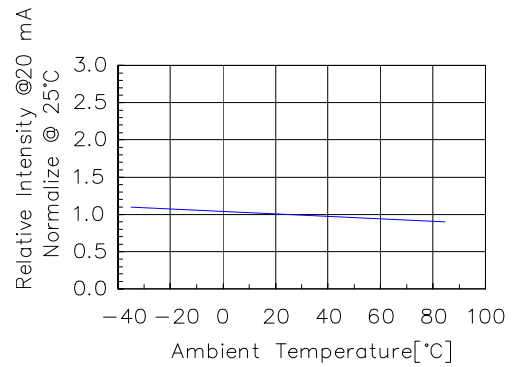

Fig 4. Relative Intensity vs. Temperature

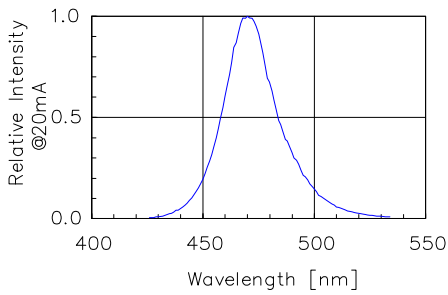

Fig 5. Relative Intensity vs. Wavelength

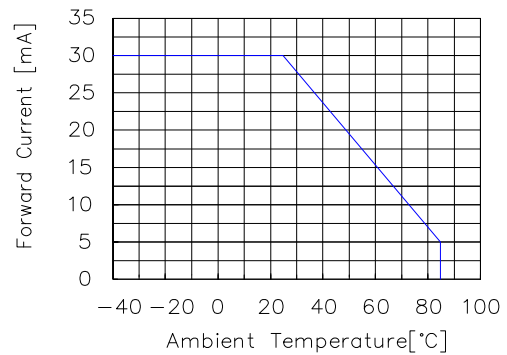

Fig 6. Forward current vs. Temperature

■ Precautions For Use -

1.Wave Soldering Profile

Distance:1.6mm min(From seating plane)

Item	Condition		Note
Preheat	Temperature T1	80 – 120°C	PWB temperature (Soldering side surface)
	Time t1	60 – 180sec	
Solder Dip	Temperature T2	230 – 260°C	Bath temperature
	Time t2	2 – 4sec	Solder tank passage time

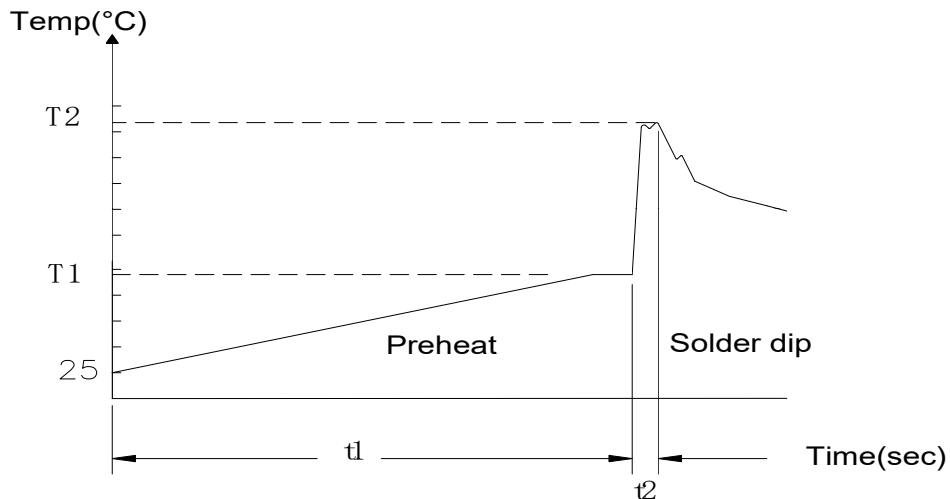

2.Hand Soldering (Iron Condition)

Soldering Iron:30W Max

Temperature 350°C Max

Soldering Time:3 Seconds Max(One Time)

Distance:1.6mm min(From seating plane)